

2016+ Can-Am Defender 2-Door & 4-Door Models



We highly recommend the installation of this stereo top to be performed by an authorized AudioFormz dealer. Warranty of stereo top and/or components may be voided if not installed correctly.





INCLUDED HARDWARE	
QTY	ITEM
6	1/4" -20 Nylon Lock Nuts
6	1/4" -20 x 2" Bolts
2	1 1/4" SS Washers (Front)
6	1" SS Washers
4	Small Silver 1/4" Washers

Limited/cab model roofs include wiper hose connection



Step 1 Attach the rear light bar

A) Using the predrilled holes, install the REAR light bar on the new roof first.  1A →

B) The rear light bar wire will fit over the rear roll bar when the roof is set on the vehicle.  1B →

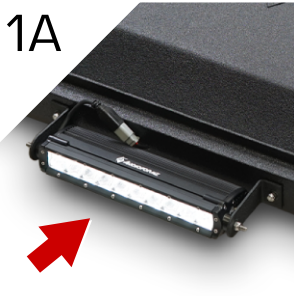

1A

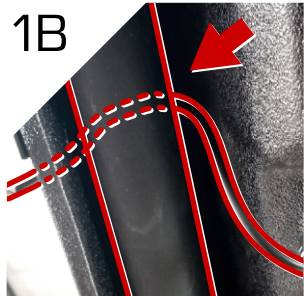

1B





Step 2 Remove the existing roof

A) Models with doors: Keep the rear doors shut until the new roof is secure. Loosen the top rear door hinges, and swing the rear plate of the hinges out of the way.  2A →

B) Models with doors: Loosen the lower rear door outer hinge bolts behind the painted panel. This will make adjustment easier after install.  2B →

C) Remove the existing roof and the rear window, if equipped.

D) Install foam strip above windshield hinges as shown.  2D →

E) Limited/Cab Models: Inside the cab, remove the upper console panel and remove the top-most bolt and nut underneath this panel as shown.  2E → Will be replaced when the roof is secured.



2A

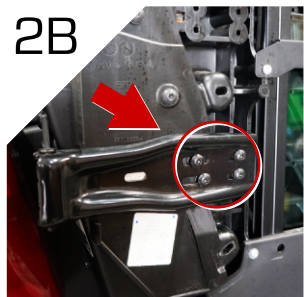

2B



2D



2E

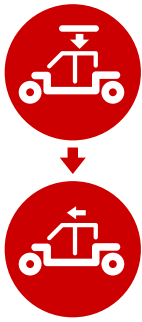

Step 3 Set the new roof on roll cage

A) Set the top on the roll cage and line it up.

B) IMPORTANT: PUSH THE ROOF ALL THE WAY FORWARD, making sure the roof is even on both sides in the rear.

IMPORTANT: If roof does not sit properly, check roll cage for squareness. All 4 corners should have equal measurements. Loosen upper cage bolts to adjust if necessary. Contact AudioFormz for further assistance.



**We recommend 2+ people to help install
Roofs require team lift!**





Repeat this step for both sides

Step 4 Secure the rear part of the roof

A) Find the 2 threaded locations in the back of the roll cage and line up the pre-drilled holes at the back of the roof with them. Roof must be lifted up slightly for holes to line up. Holes may need to be enlarged to fit due to roll cage variance.

B) If equipped with a rear window, reinstall it now. Window should fit snug.

C) Models with doors: Secure the upper door hinges during the next step. Doors may need to be realigned after the front of the roof is secured.  4C →

D) With the 1/4"-20 x 2" bolts, nuts and silver washers provided, secure the back of the roof as shown.  4D →

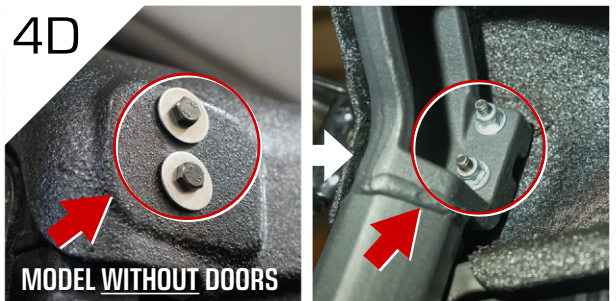

Repeat this step for both sides

Step 5 Secure the front of the roof

A) Make sure the roof is lined up and use a 1/4" bit to drill a hole through the front of the roof as shown.  5A →

B) Place a 1/4"-20x 2" bolt with a 1/4" SS washer through the top of the roof. Use a 1/4"-20 nylon locking nut and a 1" SS washer from underneath to secure the front of the roof as shown.  5B →

C) Tighten all bolts and nuts from the previous steps.

D) Models with doors: Tighten all rear door hinge bolts. Doors should be realigned if needed at this point.

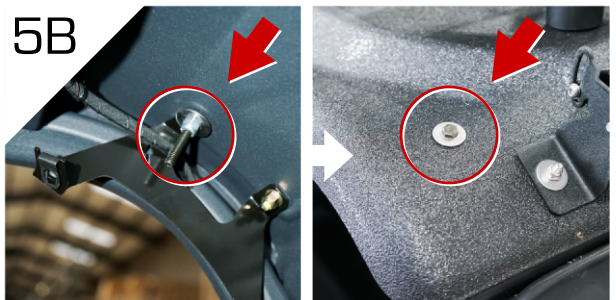



Step 6 Connect roof to power

A) Limited or cab models: There is a 3-post distribution block at the top-front of the roll cage. It should be connected as shown.  **6A** ➔

B) Limited or cab models: Connect the clear wiper hose at the front, as well as the wiper hose and two wires at the rear (small black and white wires). Cut any excess wiper hose.  **6B** ➔

C) Limited or cab models: Connect the door/window harnesses towards the sides of the roof.  **6C** ➔

D) Run the wire down the roll cage to the battery. **Fuse holder must be properly installed within 18" of the battery.** Connect to the battery on the passenger side.



Fuse Holder / Battery Installation guide (PDF)

➔ [Audioformz.com/battery-connection/install](https://audioformz.com/battery-connection/install)

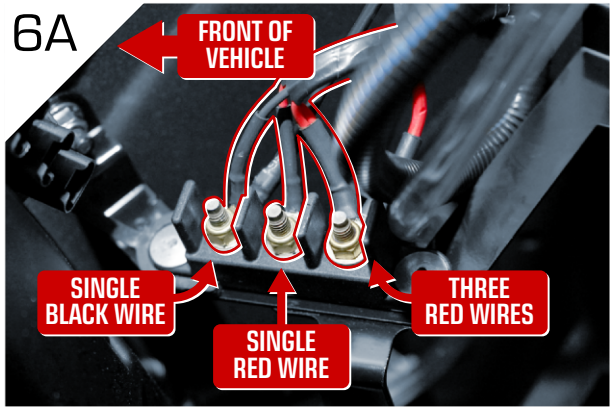

For any other questions or concerns please contact us at:

(888) 919-1990 or info@audioformz.com



To download and install the AF LED app for your smartphone, tap or scan here ➔



AF LED App / RF Remote Operation Instructions (PDF)

➔ [Audioformz.com/af-led-operation](https://audioformz.com/af-led-operation)



[Audioformz.com/af-led](https://audioformz.com/af-led)

AudioFormz Roof Rack

Defender - 2-Door/4-Door



We highly recommend the installation of this roof rack to be performed by an authorized AudioFormz dealer. Warranty of stereo top and/or components may be voided if not installed correctly.



MOUNTING HARDWARE			
QTY	ITEM	QTY	ITEM
2	1/4"-20 x 5" SS Bolts (Front)	2	1 1/4" SS Washers (Front top)
4	1/4"-20 x 2.5" SS Bolts	10	1" SS Washers
6	1/4"-20 Nylon Lock Nuts	2	Rubber Spacers (Front)

ASSEMBLY HARDWARE (4-Door)	
QTY	ITEM
24	Allen Head SS Bolts
24	SS Locking Flange Nuts
2	Wiring Harnesses
1	Light Bar Adjusting Tool
	Assorted Zip Ties

ASSEMBLY HARDWARE (2-Door)	
QTY	ITEM
8	Allen Head SS Bolts
8	SS Locking Flange Nuts
2	Wiring Harnesses
1	Light Bar Adjusting Tool
	Assorted Zip Ties

Roof racks with a mesh platform include 1/4"-20 hex bolts (Qty: 18)



Step 1

Place the rack on the floor upside-down as shown ↓



1

Step 2

Attach the rear section to the sides using the supplied hex bolts and locking nuts as shown, but do not tighten. ↓

2

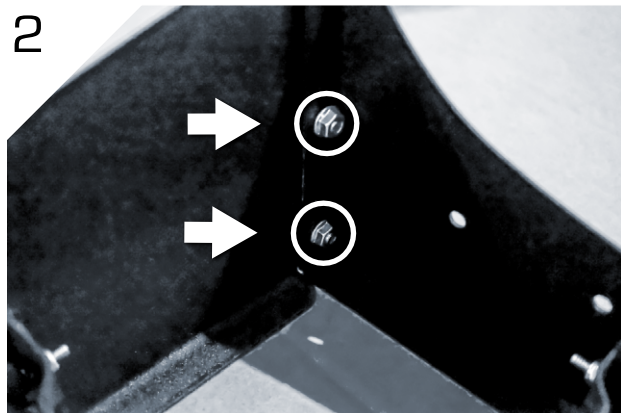
Step 3

Attach the front section to the sides using the supplied hex bolts and locking nuts as shown, but do not tighten. →

3



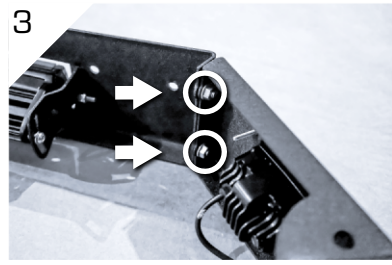

Step 4

Attach the center braces to the sides using the supplied hex bolts and locking nuts as shown ↓

4

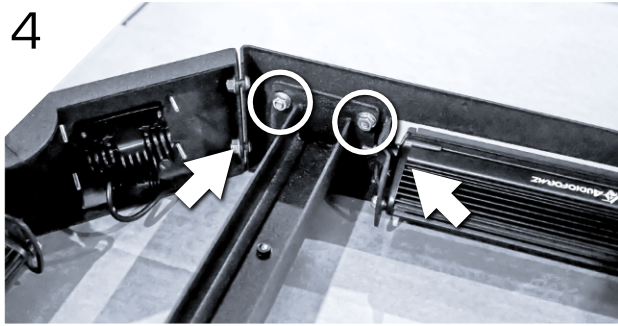

Step 5 (For models **without** a mesh platform, tighten all bolts and skip to **Step 6**.)

Flip the roof rack over and attach the mesh platform as shown. ↓

5

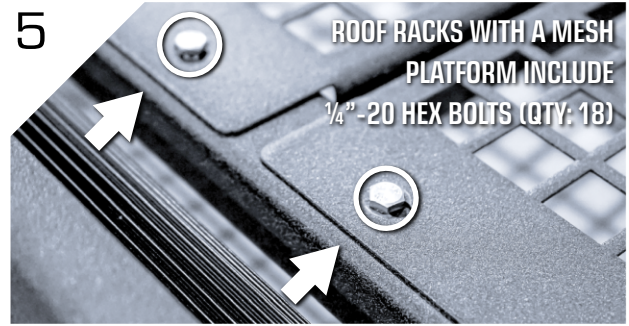

Step 6

A) With all bolts tightened, Set the roof rack on top of the roof and connect all lights. Secure the rear section of the roof rack to the back of the roof using the supplied hex bolts, locking nuts and washers as shown ➔

B) Using the two front mounting holes of the rack as a guide, use a 3/8" bit to drill out a pilot hole through the roof from the bottom using the factory bolt holes as shown ➔

Secure the front section of the roof rack using the supplied rubber spacers, hex bolts using the front factory holes shown here ➔

6A

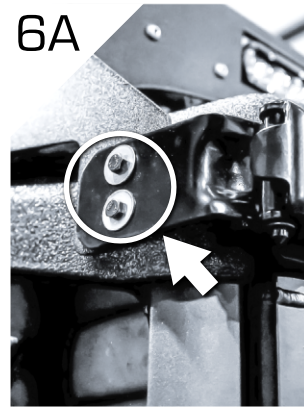

6B



NOTE: Rear of roof will be marked with white dots to drill through.

RTV Silicone is recommended to be applied under washers before securing back to roof to prevent any future leaks.

For any other questions or concerns please contact us at:

(888) 919-1990 or info@audioformz.com